

DADOS TÉCNICOS / CONSTRUCTION INFORMATION

ASSENTO / *Seat*

Espuma / Fixo / Percinta

Foam | Fixed | Webbing

ENCOSTO / *Back*

Espuma / Fixo

Foam | Fixed

ISHI PUFE QUADRADO

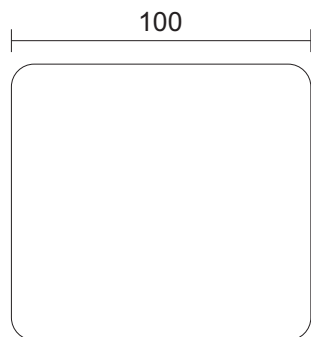
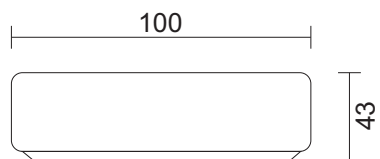

ISHI 0,96 S/BR RECUO (E / D)

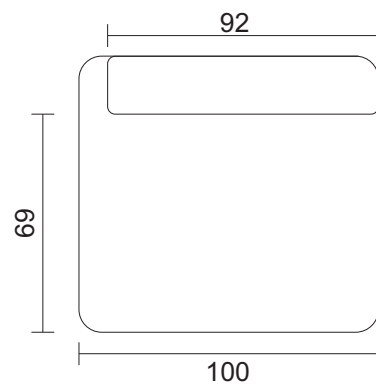
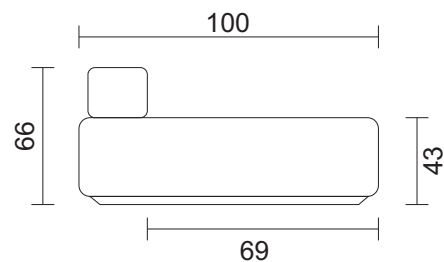

ISHI PUFE TRIANGULAR

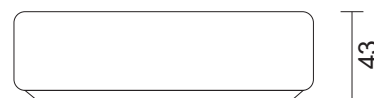

ISHI PUFE RETANGULAR

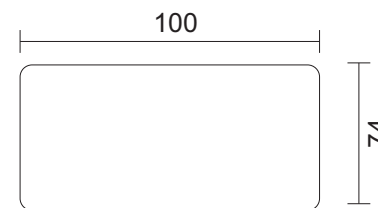
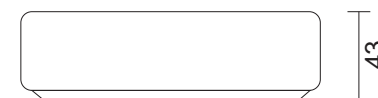

ISHI

DADOS TÉCNICOS / CONSTRUCTION INFORMATION

ASSENTO / *Seat*

Espuma / Fixo / Percinta

Foam | Fixed | Webbing

ENCOSTO / *Back*

Espuma / Fixo

Foam | Fixed

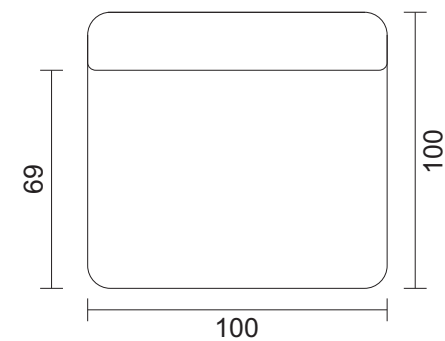
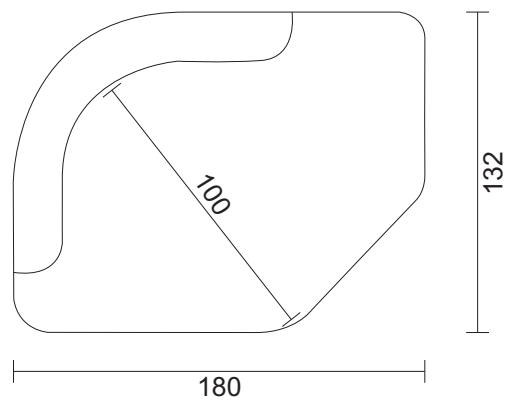
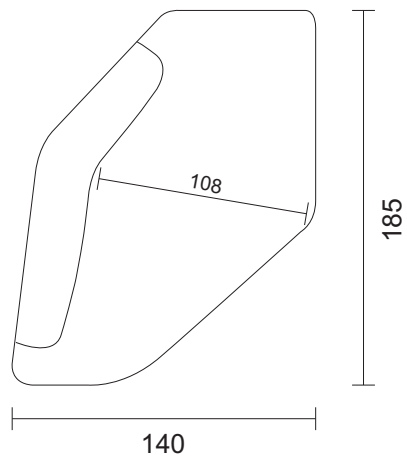
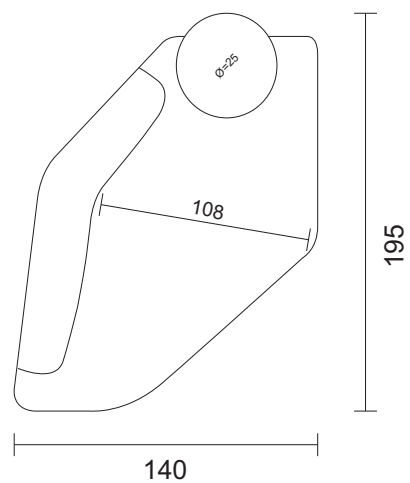
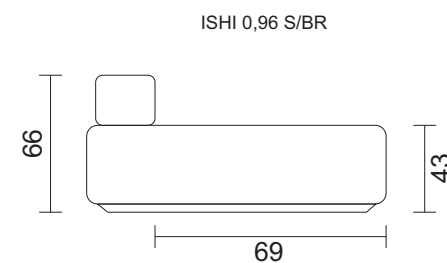
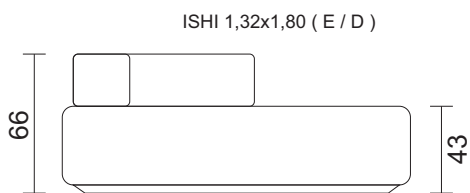
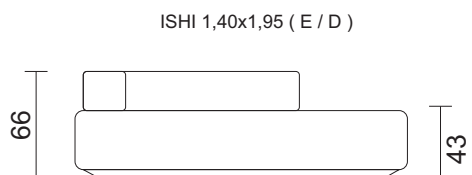
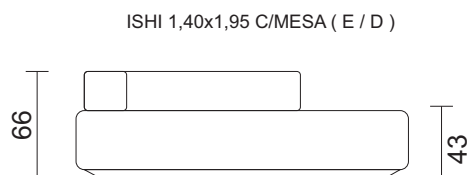

DADOS TÉCNICOS / CONSTRUCTION INFORMATION

ASSENTO / *Seat*

Espuma / Fixo / Percinta

Foam | Fixed | Webbing

ENCOSTO / *Back*

Espuma / Fixo

Foam | Fixed

ISHI 1,40x1,95 C/MESA DIR

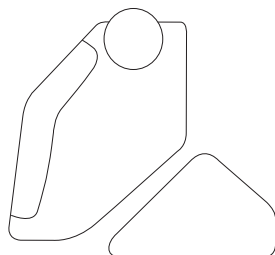

ISHI PUFE TRIANGULAR

ISHI 1,40x1,95 C/MESA DIR ISHI 0,96 S/BR RECULO ESQ ISHI 1,32x1,80 ESQ

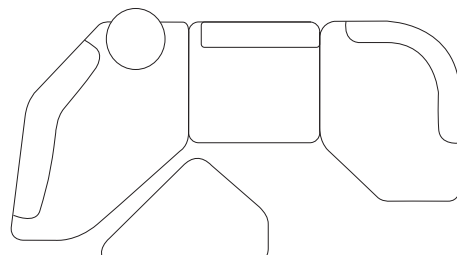

ISHI PUFE TRIANGULAR

ISHI 1,40x1,95 C/MESA DIR ISHI PUFE QUADRADO ISHI 0,96 S/BR RECULO ESQ ISHI 0,96 S/BR RECULO DIR ISHI 1,32x1,80 ESQ

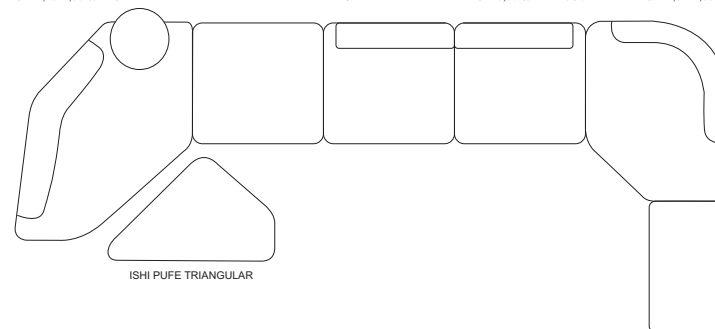

ISHI PUFE TRIANGULAR

ISHI PUFE RETANGULAR

ISHI 1,40x1,95 C/MESA DIR ISHI PUFE QUADRADO 1,00 s/br Recuo - D

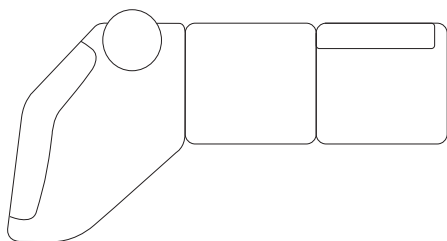

ISHI PUFE QUADRADO

ISHI 1,32x1,80 ESQ

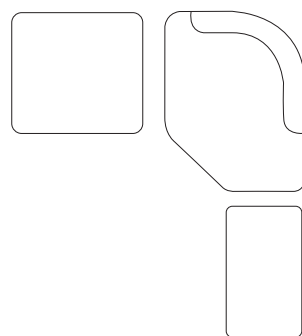

ISHI PUFE RETANGULAR

ISHI PUFE RETANGULAR ISHI 0,96 S/BR RECULO DIR ISHI 0,96 S/BR RECULO ESQ ISHI PUFE QUADRADO ISHI 1,32x1,80 DIR

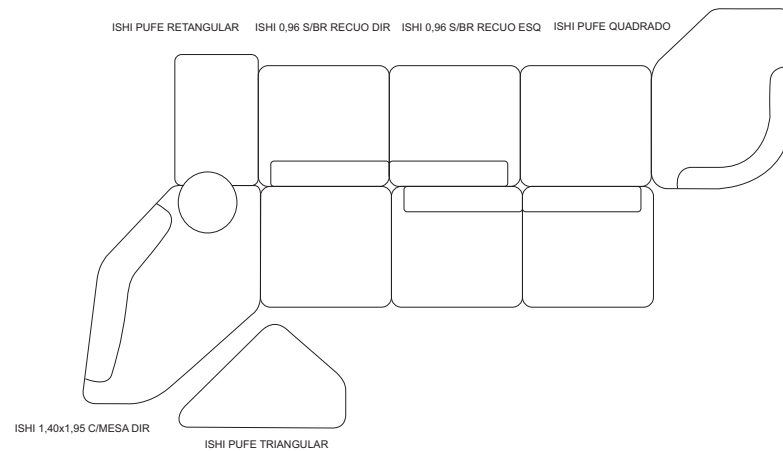

ISHI 1,40x1,95 C/MESA DIR

ISHI PUFE TRIANGULAR